

# KR2000 SERIES GRAPHIC RECORDER



KR2000 Series are network-compatible paperless recorders with high performance and high operating function employed high visibility 5.6" TFT color LCD display. High speed of sampling rate 100ms for 12 points and high accuracy of  $\pm 0.1\%$  were realized, and measured data is stored into internal memory and maximum 2GB compact flash card (CF card). As it can be monitored by a web browser display on several computers on intranet or internet, FTP transfer of data file and E-mail notification are also available.



## ■ FEATURES

- **Employing clear 5.6" TFT color LCD display**
  - Large-sized high visibility display with various display functions. Real time/Historical trend screen, Bar-graph screen, Data screen are selectable for various applications.
- **Large capacity of data memory and various recording method**
  - Compact flash card (CF card) slot is equipped as standard external memory. Large capacity storage of maximum 2GB is available.
  - Various data storing methods are selectable such as schedule programming by time of day and time of date, recording start-up by external signal, and event and data logging of before and after trigger points for alarm.
- **Multi points recording with high speed/accuracy**
  - High-speed recording of approximately 100ms for 12 points and high accuracy of  $\pm 0.1\%$  were realized. Stable measuring and recording are possible with high speed.
  - High withstand voltage of 1000V AC between input channels.
- **Easy operating and programming without manual**
  - Easy operating by dedicated keys for each function.
  - USB port is prepared in front compartment. Setups, readout of data and files are possible by connecting the panel mounted recorder with a lap-top computer.
- **LAN network capability**
  - Various networked environment such as remote monitoring by browser, FTP server and E-mail notification are applied as Ethernet is equipped as standard.
- **Safety system and reliability**
  - No battery backup needed for external memory for recorded data storage.
- **Analyzing/data acquisition application software**
  - It is easy to replay and edit the recorded data file. Replay display has functions of vertical/horizontal trend, circular trend, and also wave-analyzing and marking by using the cursor.

## ■ MODELS

- KR21 - A
- **Measuring points/sampling rate\***
    - 60: 6 points/100ms
    - 20: 12 points/100ms
    - 61: 6 points/1s
    - 21: 12 points/1s
  - **Communications interface (option)**
    - N: None
    - R: High-order (RS232C/RS485)
    - Q: High-order (RS232C/RS485) + Low-order (RS485)
  - **Digital input/ alarm output (option)**
    - 0: None
    - 1: Mechanical relay output - 12 points (a contact)
    - 2: Mechanical relay output - 6 points (c contact)
    - 7: Digital input - 8 points + MOS relay output 8 points

\* 1 to 4 channels input (4 points) when setting faster than 500ms sampling rate with model of 1sec sampling rate.

## SCREENS

### Real-time trend screen

Displays data (measured and virtual) of selected group. Vertical trend and horizontal trend selectable.

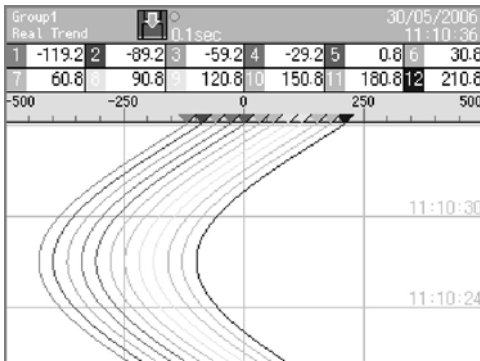

### Bar-graph screen

Displays data (measured and virtual) of selected group. Combination display with real-time trend is available.

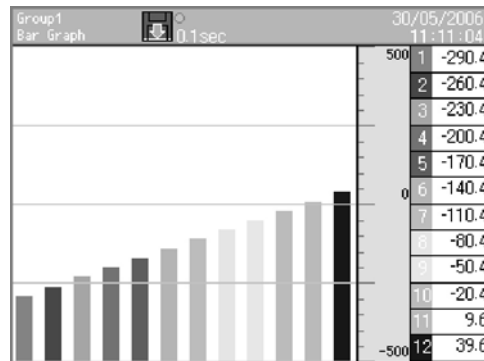

### Data screen

Displays data (measured and virtual) of selected group. Simultaneous display of alarm status.

CH1	CH5	CH9
-92.1 nJ	27.9 nJ	147.9 nJ
CH2	CH6	CH10
-62.1 nJ	57.9 nJ	177.9 nJ
CH3	CH7	CH11
-32.1 nJ	87.9 nJ	207.9 nJ
CH4	CH8	CH12
-2.1 nJ	117.9 nJ	237.9 nJ

### Dual trend screen

2 split display for real-time trend and historical trend. Scroll available for historical trend.

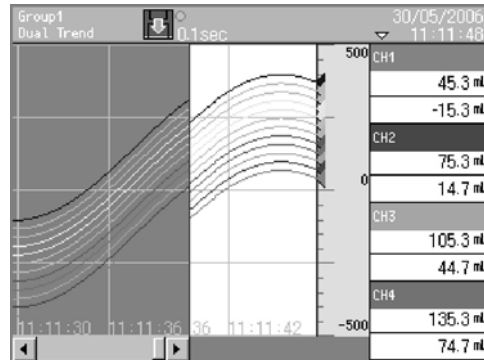

### Information screen

Start date and time	End date and time	Data count
30/05/2006 11:18:02	30/05/2006 11:18:04	30
30/05/2006 11:17:58	30/05/2006 11:18:00	28
30/05/2006 11:17:54	30/05/2006 11:17:56	24
30/05/2006 11:17:50	30/05/2006 11:17:52	26
30/05/2006 11:17:44	30/05/2006 11:17:47	38
30/05/2006 11:17:40	30/05/2006 11:17:43	33
30/05/2006 11:17:35	30/05/2006 11:17:38	38
30/05/2006 11:17:31	30/05/2006 11:17:34	36
30/05/2006 11:17:27	30/05/2006 11:17:30	33
30/05/2006 11:17:24	30/05/2006 11:17:26	26
30/05/2006 11:17:18	30/05/2006 11:17:22	49
30/05/2006 11:17:12	30/05/2006 11:17:17	54
30/05/2006 11:17:04	30/05/2006 11:17:11	73
30/05/2006 11:16:49	30/05/2006 11:17:03	145
30/05/2006 11:16:42	30/05/2006 11:16:48	62
30/05/2006 11:16:02	30/05/2006 11:16:40	382
30/05/2006 11:10:45	30/05/2006 11:17:14	4900

### HOME setting screen

Range type	500mJ		
Range	-500.0	to	500.0
Scale	-500.0	to	500.0
RJ	External		
Burn out	NONE		
Recording period	0.1 sec.		
Specification			

### Channel setting screen

CH	Range type	Tag	Unit
01	500mJ		mJ
02	500mJ		mJ
03	500mJ		mJ
04	500mJ		mJ
05	500mJ		mJ
06	500mJ		mJ
07	500mJ		mJ
08	500mJ		mJ
09	500mJ		mJ
10	500mJ		mJ
11	500mJ		mJ
12	500mJ		mJ
13	10U		U
14	10U		U

### Schedule setting screen

Date settings	Date	Time
Start Date and time	01/01/05	00:00
End Date and time	02/01/05	00:00
Day setting	Sun Mon Tue Wed Thu Fri Sat	
Usage days	<input type="checkbox"/> <input type="checkbox"/> <input type="checkbox"/> <input type="checkbox"/> <input type="checkbox"/> <input type="checkbox"/> <input type="checkbox"/>	
Start time	00:00	
End time	00:00	

## INPUT SPECIFICATIONS

Measuring points: 6 points, 12 points  
 Input types: Universal  
 DC voltage ---  $\pm 13.8\text{mV}$ ,  $\pm 27.6\text{mV}$ ,  $\pm 69.0\text{mV}$   
 $\pm 200\text{mV}$ ,  $\pm 500\text{mV}$ ,  $\pm 2\text{V}$   
 $\pm 5\text{V}^*$ ,  $\pm 10\text{V}^*$ ,  $\pm 20\text{V}^*$ ,  $\pm 50\text{V}^*$   
 (\*with built-in voltage divider)  
 DC current --- With external shunt resistor (sold separately)  
 Thermocouple --- B, R, S, K, E, J, T, N, PtRh40-PtRh20,  
 W-WRe26, WRe5-WRe26, Platinel, NiMo-Ni, CR-AuFe, U, L  
 Resistance thermometer --- Pt100, JPt100, Pt-Co, Pt50  
 Refer to the table of measuring range and accuracy ratings  
 Accuracy ratings: Refer to the table of measuring range and accuracy ratings  
 Reference junction compensation accuracy:  
 K, E, J, T, N, Platinel ---  $\pm 0.5^\circ\text{C}$  or less  
 R, S, W-WRe26, WRe5-WRe26, NiMo-Ni, CR-AuFe, U, L ---  $\pm 1.0^\circ\text{C}$  or less  
 Sampling rate: 100ms --- Approximately 100ms for all points  
 1s --- Approximately 300ms for all points\*  
 \*100ms/4 points (1 to 4 channels input) when setting faster than 500ms sampling rate with model of 1sec sampling rate.  
 Burnout: Disconnection of input signal is detected on thermocouple and resistance thermometer input. UP/DOWN/DISABLE is selectable.  
 Scaling: Range/scale is selectable.  
 Digital filter: Programming FIR filter for each point (common to all points)  
 Allowable signal source resistance:  
 Thermocouple input (burnout disable)/  
 DC voltage input ( $\pm 2\text{V}$  or less) ---  $1\text{k}\Omega$  or less  
 DC voltage input ( $\pm 5\text{V}$  or more) ---  $100\Omega$  or less  
 Resistance thermometer --- Per wire  $10\Omega$  or less (same resistance for 3 wires)  
 Input resistance: DC voltage, thermocouple input --- Approximately  $1\text{M}\Omega$   
 Maximum input voltage: DC voltage input ( $\pm 2\text{V}$  or less)/  
 thermocouple input (burnout disable) ---  $\pm 10\text{VDC}$   
 DC voltage input ( $\pm 5\text{V}$  to  $\pm 50\text{V}$ ) ---  $\pm 60\text{VDC}$   
 Dielectric strength between channels:  
 1000V AC or more between each channel  
 (High strength semiconductor relay used)  
 (B terminal of resistance thermometer is shorted inside between channels)

## RECORDING SPECIFICATIONS

Memory for history: 132MB  
 Additional memory: CF card (Up to 2GB)  
 Recording cycle: 100, 200, 500ms  
 1, 2, 3, 5, 10, 15, 20, 30s  
 1, 2, 3, 5, 10, 15, 20, 30, 60min  
 Logging data: Measured data --- File name (group name), time of day, month and year of recording start, tag, measured data, alarm status/types  
 Setting parameter  
 Binary/CSV  
 Storing types: Manual start/stop (dedicated key operation)  
 Storing methods: Schedule (designation for time of day and date)  
 Trigger signal (alarm event, digital input)  
 \*Pre-trigger is selectable  
 Measuring numbers of pre-trigger --- Maximum 950 data  
 Recording group: Recording cycle 500ms or faster --- up to 3 groups of 12 points/group can be programmed  
 Recording cycle 1s or slower --- up to 5 groups of 44 points/group can be programmed (Up to total of 100 points)

When 6 channels recorded in sampling mode (real data).

Recording cycle	128MB	256MB	512MB	1GB	2GB
0.1 sec	6.32 days	12.6 days	25.3 days	50.6 days	101 days
1sec	63.2 days	126 days	253 days	1.4 yrs	2.8 yrs
60 sec	10 yrs	21 yrs	42 yrs	83 yrs	166 yrs

When 12 channels recorded in sampling mode (real data).

Recording cycle	128MB	256MB	512MB	1GB	2GB
0.1 sec	3.16 days	6.32 days	12.6 days	25.3 days	50.6 days
1sec	31.6 days	63.2 days	126 days	253 days	1.4 yrs
60 sec	5.2 yrs	10 yrs	21 yrs	42 yrs	83 yrs

## COMPUTATION SPECIFICATIONS

Computation points: Maximum 44 points  
 Computation types: Arithmetic operations --- Addition, subtraction, multiplication, division, remainder, exponential  
 Comparison operations --- Equality, inequality, great, less, equality /great, equality / less  
 Logical operations --- AND, OR, XOR, NOT  
 General functions --- Round-up, round-down, absolute value, square root, exponent of e, natural logarithm, common logarithm  
 Integration operations --- Analog integration, digital integration  
 Channel data operations --- Measured data computation, calculated data computation  
 Dew point, relative humidity, F-value  
 Others --- Remaining amount of CF card

## ALARM SPECIFICATIONS

Setups: Up to 4 alarms can be programmed per channel  
 Alarm types: Upper limit, lower limit, differential upper limit, differential lower limit (deadband is selectable), abnormal data  
 Delay function: Setup range of alarm delay --- 1 to 3600 seconds  
 Alarm settings: AND/OR selectable  
 Alarm outputs: Refer to option specification

## DISPLAY SPECIFICATIONS

Display: 5.6" TFT color LCD  
 Display types: Measured data display (Trend screen, Data screen, Bar-graph screen)  
 Historical trend display (simultaneous display with Real-time trend is available)  
 Information display (alarm display, marker list, file list)  
 Setting screen (alarm, computation, memory, system, maintenance, communication, etc.)  
 Trend screen: 12 colors selectable  
 Display screen --- 5 screens (5 groups)  
 Display points --- Maximum 44 points/screen  
 Time axis direction --- Vertical or horizontal  
 Line width --- 1/3/5 dot selectable  
 Scale display --- 4 scales  
 Tag/data display --- Show/hide selectable  
 Marker display  
 Data screen: Display screen --- 5 screens (5 groups)  
 Display points --- Maximum 44 points/screen  
 Display contents --- Measured value, channel/tag, unit, alarm status  
 Bargraph screen: 12 colors selectable  
 Display screen --- 5 screens (5 groups)  
 Display points --- Maximum 44 points/screen  
 Display direction --- Vertical or horizontal  
 Scale display --- 1 scale  
 Information display: Alarm display (alarm activation/released history display)  
 Marker list  
 File list (group data file list display)  
 LCD back light: Auto/manual OFF function  
 Unit information (Model, Serial no., option, etc.)  
 Brightness --- 4 levels adjustment  
 \*The LCD display may contain some pixels that always or never illuminate, and the brightness of some areas of the display may appear uneven. There are typical LCD performance characteristics and do not constitute malfunctions.

## COMMUNICATION FUNCTIONS

### Network

Communication type: Ethernet (10BASE-T/100BASE-TX)  
 FTP server: Data file can be read from the network computer  
 Transfer a data file to a network server  
 FTP client:  
 SNTP client: The time can be synchronized to the time of SNTP server  
 Conformed to HTTP1.0 --- Displays the alarm, information of maintenance by browser software (Internet Explorer 5.0 or later, NetScape 6.0 or later, Opera 7 or later)  
 Web server: \* User's ID and password registration available  
 E-Mail: E-Mail notification at specified time for alarm activation  
 Report data at specified time is selectable from all registered data  
 Notification address --- Maximum 8 contacts

### USB Communications

USB: Communication type --- USB1.1  
 Transfer systems --- Bulk transfer, control transfer  
 File transfer by connecting as removable disk drive

## CONNECTIVITY

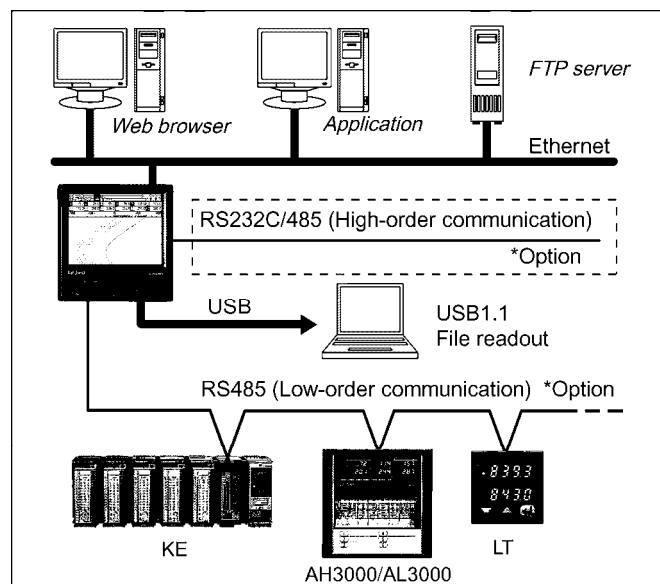

## PROGRAMMING/OPERATION SPECIFICATIONS

Operation key: HOME, MENU, DISP, MARKER, SCROLL, CURSOR, START, STOP, DIRECTION keys, ENTER, ESC

HOME settings: Simple recording settings --- Common setting to all channels  
Parameter programming for all channels together, recording cycle, selection settings

MENU settings: Input/computation programming --- Input parameter, computation parameter  
DISP settings --- Data channel parameter, group parameter, common parameter (combination display, trend vertical/horizontal)  
Alarm settings  
File settings (5 individual files) --- Storing method settings  
Marker text settings  
System settings --- Communication, clock, maintenance, key lock, password, screen, etc.

DISP operations: Operating screen selection --- Trend, data, bar-graph, historical trend, alarm display, maker list  
Display selection on each screen --- Group 1 to 5 selectable

## GENERAL SPECIFICATIONS

Rated power voltage: 100 to 240V AC (universal power supply) 50/60Hz  
Maximum power consumption: 50VA

Reference operating condition:  
Ambient temperature --- 21 to 25°C,  
Ambient humidity --- 45 to 65%RH  
Power voltage --- 100V AC±1.0%  
Power frequency --- 50/60Hz±0.5%  
Attitude --- Left/right 0°, forward/backward 0°  
Warm-up time --- Longer than 30 minutes

Normal operating condition:  
Ambient temperature --- 0 to 50°C  
Ambient humidity --- 20 to 80%RH  
Power voltage --- 90 to 264V AC  
Power frequency --- 50/60Hz±2%  
Attitude --- left/right 0°, forward tilting 0°, Backward tilting 0° to 20°

Transport condition (at the packed condition on shipment from our factory):  
Ambient temperature --- -20 to 60°C  
Ambient humidity --- 5 to 90%RH (No dew condensation)  
Vibration --- 10 to 60Hz 0.5G (4.9m/S<sup>2</sup>) or less  
Impact --- 40G (392m/ S<sup>2</sup>) or less

Storage condition:  
Ambient temperature --- -20 to 60°C  
Ambient humidity --- 5 to 90%RH (No dew condensation)

Power failure protection: Setups and data are backed up by flash memory  
Clock --- Lithium battery backs up RAM (Minimum 5 years)

Insulation resistance: Secondary terminals and protective conductor terminals --- 20MΩ or more at 500V DC  
Primary terminals and protective conductor terminals --- 20MΩ or more at 500V DC  
Primary and secondary terminals --- 20MΩ or more at 500V DC  
Primary terminals: power terminals (L,N), alarm output terminals  
Secondary terminals: measuring input terminals, digital input terminals, communications terminals

Dielectric strength: Secondary terminals and protective conductor terminals --- 1 minute at 500V AC  
Primary terminals and protective conductor terminals --- 1 minute at 1500V AC  
Primary and secondary terminals --- 1 minute at 2300V AC  
Primary terminals: power terminals (L,N), alarm output terminals  
Secondary terminals: measuring input terminals, digital input terminals, communications terminals

Case assembly material: Front bezel --- ABS resin  
Case --- Steel

Color: Front bezel --- Black (equivalent to Mussel N3.0)  
Case --- Painting color, gray (equivalent to Mussel N7.0)

Weight: 2.2kg  
Mounting: Panel mounting  
Terminal screws: Power terminals/protective conductor terminals/communications terminals --- M4.0  
Measuring input terminals/alarm output terminals/digital input terminals --- M3.5

## STANDARDS

CE : EMC directive --- EN61326: 1997 + A1 + A2 + A3: 2003 Class A  
EN61000-3-2: 2000  
EN61000-3-3: 1995 + A1: 2001  
Low voltage directive --- EN61010-1: 2nd ed. (2001)  
Protection: Conformed to IEC529 IP65 (recorder front bezel)

## OPTION SPECIFICATIONS

Options	Specifications	
Mechanical relay alarm output	Mechanical relay contact output for abnormal input and alarm activation Output: 12 points (a contact), 6 points (c contact) Contact ratings: Mechanical relay --- 100V AC 0.5A, 240V AC 0.2A, 30V DC 0.3A	
MOS relay alarm output	MOS relay contact output for abnormal input and alarm activation Output: 8 points Contact ratings: MOS relay --- 240V (DC, AC) 50mA	
Communications interface	High-order communications	Communications interface for high-order units RS232C/RS485 (MODBUS) switchable Ethernet is standard equipped
	Low-order communications	Communications interface for low-order units Input data storing of units connected to low-order RS485 (MODBUS) Recording points: 6 points recorder --- 30 points 12 points recorder --- 24 points Sampling rate: 1s per connected unit Models: KE, SE3000, KR2000, KR3000, LE5000, AL3000/AH3000, LT230, 830, 350, 450, 470, JU, JW
Digital inputs	ON/OFF signal	ON/OFF input recording
	Pulse input	Maximum 10Hz pulse input Used for flow, operating time and frequency Input system: Photocoupler isolation (Common use for contact and pulse input) Built-in isolated power supply (approx. 5V) Input type: Non-power contact, open collector (TTL or transistor)
	Remote contact	The following operations are available by contact input 8 points and common signal 4 points (Selectable by parameter). • Data memory triggering Start data recording by conductive signal from OFF to ON Data recording while conductive signal is ON • Marker display Registered makers display by conductive signal from OFF to ON • Integration operations Reset data for integration operations (all channels simultaneously)
Others	Handle and feet, white front bezel, point indication card	

## OPERATION KEYS

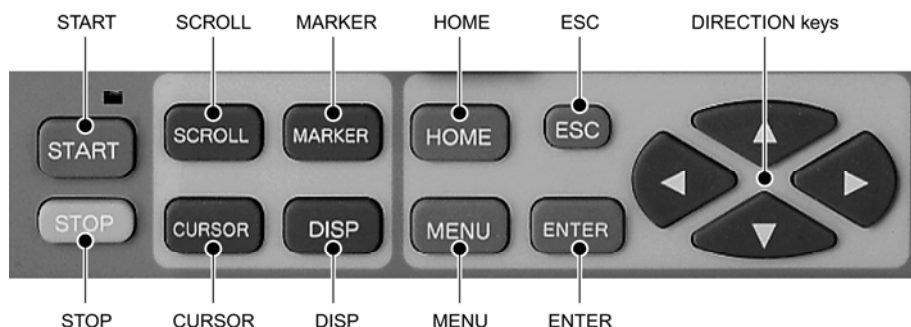

## MEASURING RANGES/ACCURACY RATINGS

Input type	Measuring range	Accuracy rating	
DC voltage	-13.80 to 13.80mV	±0.1%±1digit	
	-27.60 to 27.60mV		
	-69.00 to 69.00mV		
	-200.0 to 200.0mV		
	-500.0 to 500.0mV		
(with built-in voltage divider)	-2.000 to 2.000V		
	-5.000 to 5.000V		
	-10.00 to 10.00V		
	-20.00 to 20.00V		
	-50.00 to 50.00V		
T/C	K	-200.0 to 300.0°C	±0.1%±1digit * -200 to 0°C: ±0.2%±1digit
		-200.0 to 600.0°C	
		-200 to 1370°C	
	E	-200.0 to 200.0°C	
		-200.0 to 350.0°C	
		-200 to 900°C	
	J	-200.0 to 250.0°C	±0.1%±1digit *0 to 400°C: ±0.2%±1digit
		-200.0 to 500.0°C	
		-200 to 1200°C	
	T	-200.0 to 250.0°C	±0.1%±1digit *0 to 400°C: ±0.2%±1digit
		-200.0 to 400.0°C	
	R	0 to 1200 °C	±0.1%±1digit *0 to 1760 °C: ±0.2%±1digit
		0 to 1760 °C	
	S	0 to 1300°C	±0.1%±1digit *0 to 400°C: Out of accuracy ratings *400 to 800°C: ±0.15%±1digit
		0 to 1760°C	
	B	0 to 1820°C	±0.15%±1digit * -200 to 0°C: ±0.3%±1digit
	N	-200.0 to 400.0°C	
		-200.0 to 750.0°C	±0.15%±1digit *0 to 100°C: ±4%±1digit *100 to 400°C: ±0.5%±1digit
		-200 to 1300°C	
W-WRe26	0 to 2315°C	±0.2%±1digit	
WRe5-WRe26	0 to 2315°C		
PtRh40-PtRh20	0 to 1888°C	±0.2%±1digit *0 to 300°C: ±1.5%±1digit *300 to 800°C: ±0.8%±1digit	
NiMo-Ni	-50.0 to 290.0 °C		
	-50.0 to 600.0 °C	±0.2%±1digit *0 to 20K: ±0.5%±1digit *20 to 50 K: ±0.3%±1digit	
	-50 to 1310 °C		
CR-AuFe	0.0 to 280.0K	±0.15%±1digit	
Platinel	0.0 to 350.0°C		
	0.0 to 650.0°C	±0.1%±1digit * -200 to 0°C: ±0.3%±1digit	
	0 to 1395°C		
U	-200.0 to 250.0°C	±0.1%±1digit * -200 to 0°C: ±0.2%±1digit	
	-200.0 to 500.0°C		
	-200.0 to 600.0°C		
L	-200.0 to 250.0°C	±0.1%±1digit * -200 to 0°C: ±0.2%±1digit	
	-200.0 to 500.0°C		
	-200 to 900 °C		
	-200 to 900 °C		
RTD	Pt100	-140.0 to 150.0°C	±0.1%±1digit * -140.0 to 150.0°C: 700 to 850°C: ±0.15%±1digit
		-200.0 to 300.0°C	
		-200.0 to 850.0°C	
		-200.0 to 850.0°C	
	JPt100	-140.0 to 150.0°C	±0.1%±1digit * -140.0 to 150.0°C: ±0.15%±1digit
	-200.0 to 300.0°C		
	-200.0 to 649.0°C		
	Pt50	-200.0 to 649.0°C	±0.1%±1digit *4 to 50K: ±0.3%±1digit
	Pt-Co	4.0 to 374.0K	

Note: The accuracy ratings are converted into the measuring range under reference operating condition. Thermocouple input does not contain reference junction compensation accuracy.  
 K, E, J, T, R, S, B, N: IEC584, JIS C1602-1995  
 W-WRe26, WRe5-WRe26, PtRh40-PtRh20, Platinel, NiMo-Ni, Cr-AuFe: ASTM Vol14.03  
 U(Cu-CuNi), L(Fe-CuNi): DIN43710  
 Pt100: IEC751(1995), JIS C1604-1997  
 JPt100: JIS C1606-1989

## APPLICATION SOFTWARE ZAILA (sold separately)

The software is applied for replay display/wave editing operation of recorded data in KR2000 series. It has replay display of vertical/horizontal trend and circular trend function, and also analyzing function such as magnify/reduce/partially magnify of graphs and message insert.

### Display examples

Trend display window (vertical flow)

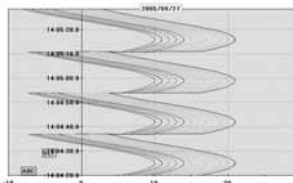

Trend display window (horizontal flow)

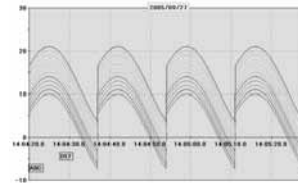

Bar-graph

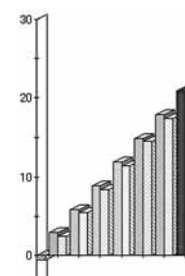

Trend display window (circular trend)

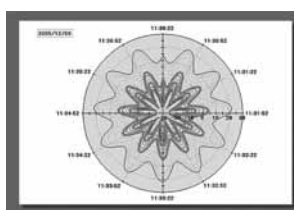

### Main functions

- Trend display  
Selectable from trend display window (vertical flow, horizontal flow) and circular trend display window.
- Continuous replay display window  
Trend is scrolled continuously (automatically).  
Scroll changes by speed and renewal data no.
- Data list display window  
Displays registered data as list display.
- Bar-graph  
Displays by bar. Message can be inserted into bar-graph.
- Data between markers  
Displays date/time, time difference between 2 data, data difference, maximum, minimum, average, standard deviation and median among all data.
- Alarm display  
Points for alarm activation at each level are displayed on a trend graph.
- Settings  
Cursor, trend line, scale axis, time axis, title input on the graph, graph assistant and magnify/reduce/rotation of graphs
- Data conversion  
Exporting to Excel, and converting to CSV file or TEXT file are available.

### ENVIRONMENT

CPU	1GHz or faster
OS	Windows 98/Me Windows 2000/XP Home/XP Pro *Internet Explorer 4.0 or later
Memory	256MB or more (512MB or more recommended)
Disk drive	CD-ROM drive: 1 drive or more Hard disk drive: Disk space of 1 drive or more for 100MB or more
Language	Japanese, English, Chinese (simplified and traditional characters), Korean

**■ TERMINAL ARRANGEMENT**

● Alarm mechanical relay alarm output 12 points (option)

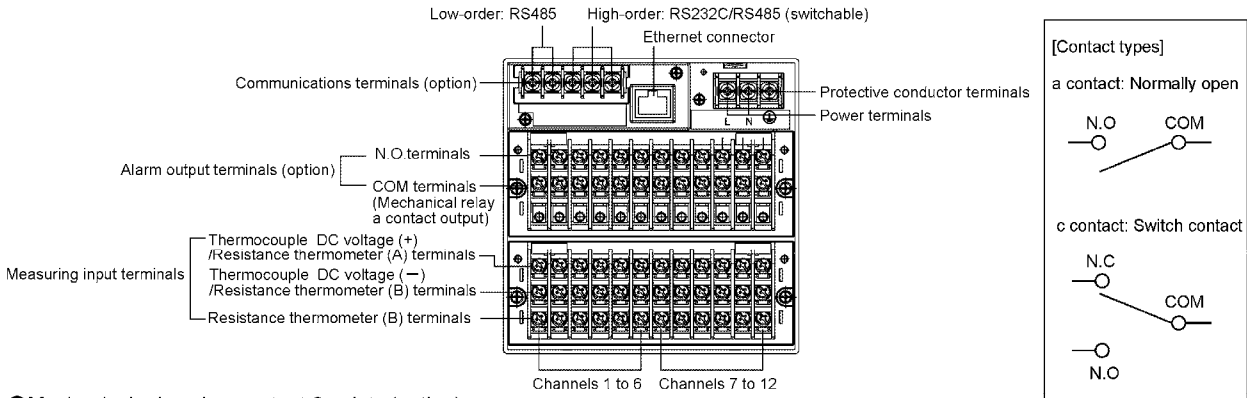

● Mechanical relay alarm output 6 points (option)

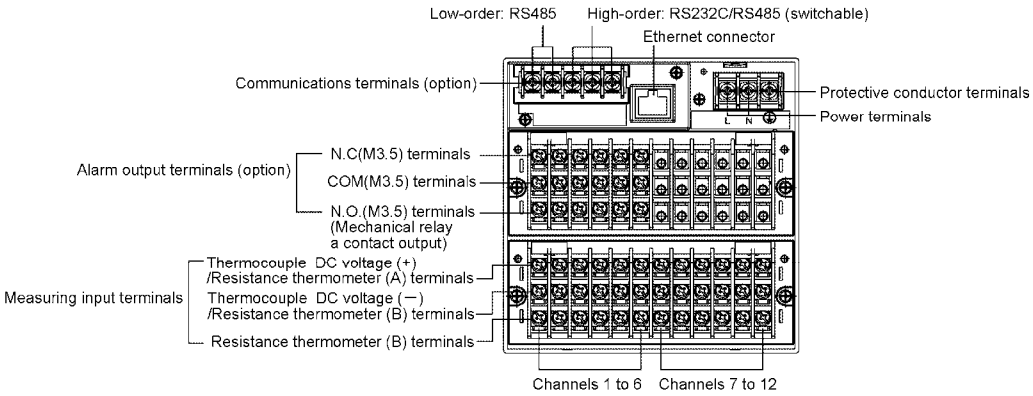

● Digital input 8 points + MOS relay alarm output 8points (option)

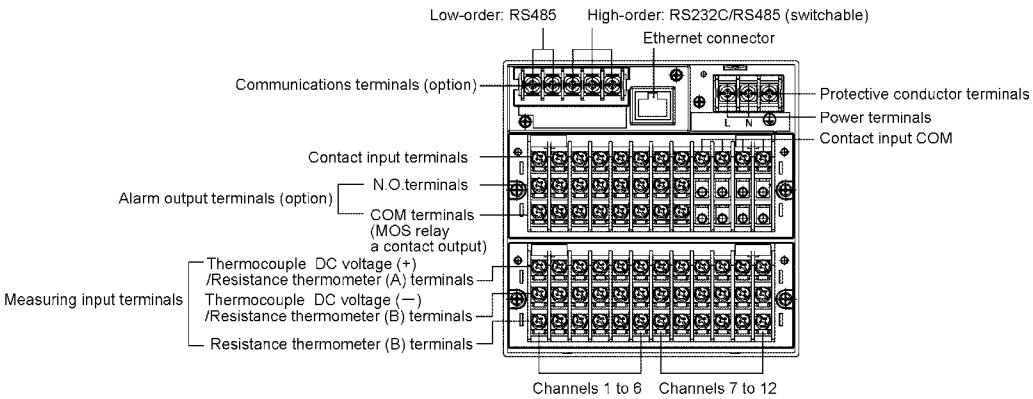

**■ DIMENSIONES**

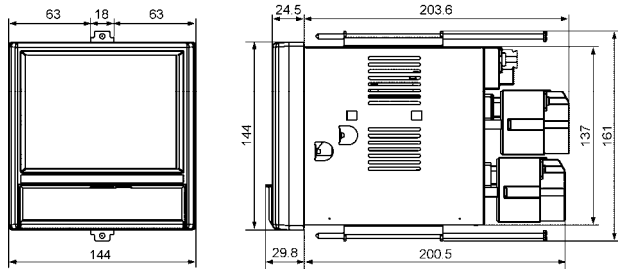

Unit: mm

**■ Panel cutout and minimum clearance**

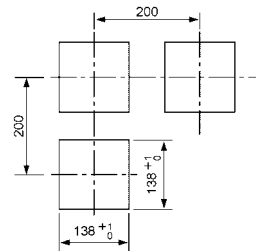

Unit: mm

Specifications subject to change without notice. Printed in Japan (I) 2008. 1 Recycled Paper

**CHINO CORPORATION**

32-8, KUMANO-CHO, ITABASHI-KU, TOKYO 173-8632

PHONE: +81-3-3956-2171

FAX: +81-3-3956-0915

E-mail: inter@chino.co.jp

Website: http://www.chino.co.jp