

COMPACT DIGITAL INDICATING CONTROLLER



MODEL DB500

The DB500 series are high-accuracy, high-speed compact controllers with digital displays and an indicating accuracy of $\pm 0.2\%$ and sampling frequency of approx. 0.2 sec., incorporating high-performance microprocessors with a front panel 48 mm wide and 96 mm high.

They have excellent functions including an auto-tuning PID function and overshoot suppression function using fuzzy logic. In addition, a communications interface can be added, enabling a system controlled by a host computer or a system using zone division control to be set up.



FEATURES

- Accurate control with ease of operation**
 The operation keys required for setting the SV, PID and alarms, etc. are simply arranged for accurate control with easy operation.
- Auto-tuning PID function**
 The optimum PID constants can be set automatically, eliminating troublesome setting operations and allowing setup in a short period of time.
- Overshoot suppression with FUZZY LOGIC**
 Overshoot which tends to occur due to sudden changes such as a change of the object to be controlled or the change of a set value in a heat treating furnace, etc. can be suppressed by fuzzy logic.
- Communications interface can be added**
 As a communications interface and transmission signal output are available as options, control using a host computer or combination with a recorder can be performed easily.
- Zone division control**
 Using the communications interface, a number of DB500s can be connected to control up to 32 zones, allowing tunnel kiln control, etc. Also, combination with a CHINO KP Series Digital Program Setter enables program control of a multi-zone batch furnace.
- Indicating accuracy of $\pm 0.2\%$ and sampling cycle of approx. 0.2 sec.**

Even though its front panel is small (48 × 96mm), high accuracy and high speed are achieved through use of a high-performance microprocessor and A/D converter.

MODELS

DB5□0—□□0

Control output

- 1: ON-OFF pulse type PID system
- 3: Current output type PID system
- 5: SSR driving pulse type PID system

Fuzzy logic function

- 0: None
- F: Provided

Communications/transmission output signal * Optional

- 0: None
- A: Communications interface RS 422A
- 1: Transmission signal 4 to 20 mA DC

MEASURING RANGE

Type of input	Scale(C)	Scale(F)	Type of input	Scale(C)	Scale(F)		
Thermocouple	B	0 to 1820	32 to 3300	Resistance thermometer	JPT	-200 to 649	-300 to 1200
	R	0 to 1760	32 to 3200		100	-200 to 150	-300 to 300
	S	0 to 1760	32 to 3200	100	PT	-200 to 649	-300 to 1200
		-200 to 1370	-300 to 2450		Old Pt150	-200 to 150	-300 to 300
	K	-200 to 300	-300 to 550	DC voltage	10mV	-10 to 10mV	—
		-200 to 700	-300 to 1250		5V	-5 to 5V	—
	E	-200 to 900	-300 to 1650	20mA	-20 to 20mA	—	
	J	-200 to 400	32 to 700				
	T	-200 to 400	32 to 700				
	NiCr	0 to 1300	32 to 2350				
U	-200 to 400	-300 to 700					
L	-200 to 900	-300 to 1650					

FUNCTIONS OF COMPONENT PARTS

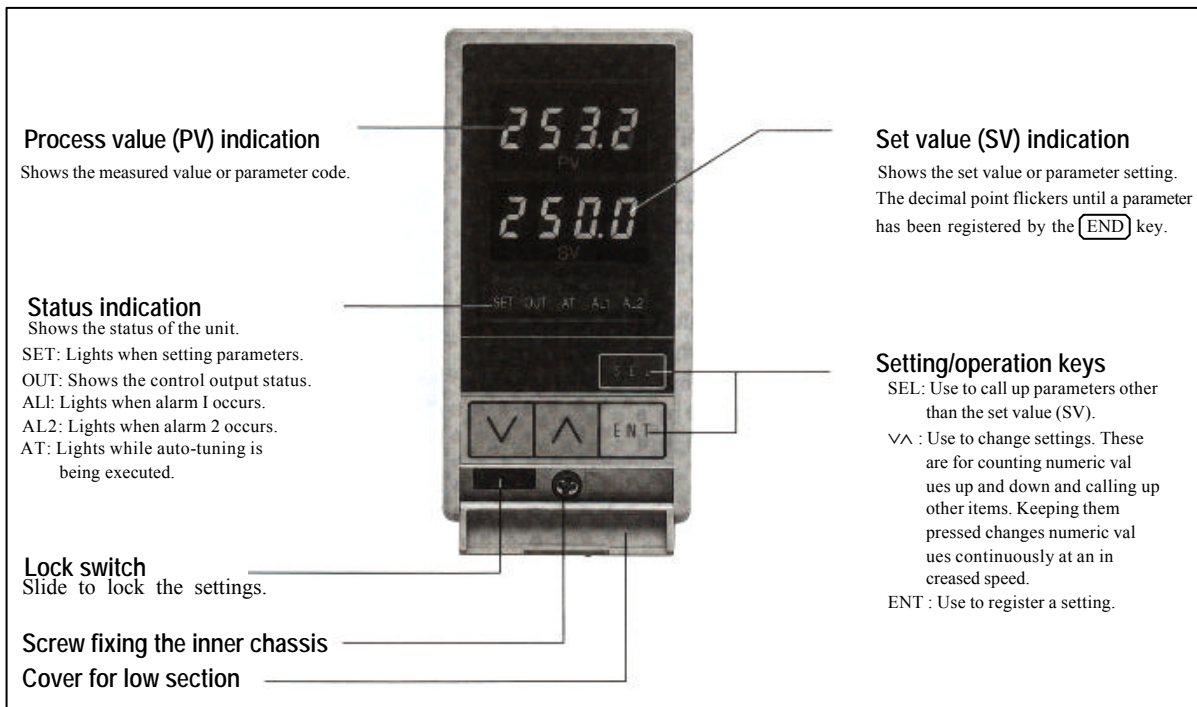

GENERAL SPECIFICATIONS

Input signal : Thermocouple B, R, S, K, E, J, T, NiCr, U, L
DC voltage/current — ± 10 mV, ± 5 V, ± 20 mA
Resistance thermometer — Pt100, JPt100, old Pt50

Measuring range: Refer to the table for the measuring ranges (with direct current input, setting within the range is possible.), multi-range for 11 types of thermocouple, 2 DC voltages, 1 DC current and 5 types of resistance thermometer (switchable with a internal switch)

Measuring accuracy: $\pm 0.2\%$ of input span ± 1 digit
The thermocouple input does not include the reference point compensation accuracy.

Reference point compensation accuracy: $\pm 0.8^\circ\text{C}$

Sampling cycle: Approx. 0.2 sec.

Burnout : Provided with thermocouple input, resistance thermometer input and mV input.
With burnout, output 0% and high limit alarm output

Measuring input shift (sensor correction)
SV (set value), -200 to 1000 times the resolution
: 0.0 to 99.9 sec.

Digital filter : Arbitrarily set from - 1999 to 9999

Scaling : Arbitrarily set from - 1999 to 9999

Scale decimal point: 0 to 3

Display method: 4 figures x 2 columns with 7-segment LED 5 individual 5 individual LEDs for status indication

Display contents
: Upper value — Color; green
In control mode, the process value (PV) is displayed.
In the setting mode, the setting parameter code is displayed.
Lower value — Color; orange
In control mode, the set value (SV) is displayed.
In the setting mode, the set content is displayed. Status
SET — Lights in the setting mode.
OUT — Lights according to output conditions.
AT — Lights during auto-tuning.
AL1 — Lights when alarm 1 occurs.
AL2 — Lights when alarm 2 occurs.

Automatic return: When no key is operated for more than 1 minute in the setting mode, the unit automatically returns to the control mode.

Unit : 'C, 'F switchable by internal switch

Power supply : 85 to 264 V AC, 50/60 Hz (switchable with an internal switch)

Working temperature range: (-) 10 to 50°C

Working humidity range: 20 to 90% RH (non-condensing)

Power failure protection: Parameters maintained in EEPROM

Allowable signal source resistance

Thermocouple/mV input — 100 Ω or less
V input — 300 Ω or less

Resistance thermometer input — 5 Ω or less for one line

Input resistance

Thermocouple/mV/V input — 1 M Ω or more

mA input — Approx. 250 Ω

Measuring current

Resistance thermometer input — Approx. 2 mA

Maximum common mode input: 250 V AC

Common mode rejection ratio: 130 dB or more

Series mode rejection ratio: 50 dB or more

Insulation resistance

Between measurement terminal and ground terminal;

500 VDC, 20 M Ω or more

Between power supply terminal and ground terminal;

500 VDC, 20 M Ω or more

Between measurement terminal and power supply

terminals;

500 V DC, 20 M Ω or more

Withstand voltage

Between measurement terminals and ground terminal;

500 V AC, 1 minute

Between power supply terminals and ground terminal;

1500 V AC, 1 minute

Between measurement terminal and power supply

terminals; 1500 V AC, 1 minute

Power consumption: Approx. 8VA

Case : ABS plastic

Color : Gray

Installation method: Panel mounted

Weight : Approx. 400g

CONTROL SPECIFICATIONS

Control switching cycle: Approx. 0.2 sec.

Control systems

- : Current output type PID system
- ON-OFF pulse type PID system
- SSR driving pulse type PID system
(2-position output possible with a switch inside)

Control set value range

: Within the measured value range

Control set accuracy rating

: Error relative to indicated value within ± 1 digit

PID constant

- : Automatic setting by auto-tuning or manual setting
- P — 0.1 to 999.9%
- I — 0 to 9999 sec. (with 0, no integration)
- D — 0 to 9999 sec. (with 0, no differentiation)

Output limiter

: High limit limiter — 0.0 to 105.0%

Low limit limiter — 5.0 to 100.0%

Output variation limit

: 0.1 to 100%

Deadband : 0.1 to 9.9% (when used at 2 positions)

Control operation

Provided with the switch inside for normal or reverse operation

Types of outputs

- : Current output type:
 - Output signal: 4DC to 20 mA
 - Load resistance: 50 Ω or less
- ON-OFF pulse type
 - Output signal; 3-point output of H, C and L using relay contact
 - Contact capacity;
 - resistance load of 100 V AC, 2 A/200 V AC, 1 A inductive load of 100 V AC, 1 A/200 V AC, 0.5 A ON-OFF pulse cycle;
 - only PID system, 1 to 100 sec. variable
- SSR drive pulse type
 - Output signal; DC voltage pulse signal
 - With ON, 12 V DC $\pm 20\%$
 - With OFF, 0.5 V DC or less
 - Load capacity; 20 mA or less
 - ON-OFF pulse cycle; only PID system, 1 to 100 sec. variable

Fuzzy logic function

- : Overshoot suppression function using fuzzy logic
- ON/OFF switchable
- (Note) This may not be effective for an object with which response is very fast such as flow rate or pressure control or heating control using a lamp, etc.

ALARM SPECIFICATIONS

Number of alarm points: 2

Output form : Relay make contact; common
Contact capacity;
resistance load of 100 V AC, 1 A/200 V AC, 0.5 A
inductive load of 100 V AC, 0.5 A/200 V AC, 0.2 A

Alarm mode : 6 modes of absolute value high limit, absolute value low limit, deviation high limit, deviation low limit, deviation high limit with standby and deviation low limit with standby can be set arbitrarily at each output point.

Alarm dead band

: 1000 times the maximum indicating resolution

OUTPUT AND DISPLAY WHEN THERE IS AN ABNORMALITY

Display	Cause	Operation of controller		
		Alarm output	Control output	Auto-tuning
Lighting	• The input value is higher than the scale range of the controller. • Burnout (with thermocouple, resistance thermometer, mV input)	High limit alarm output	0%	Stop
Lighting	• The input value is lower than the scale range of the controller.	Low limit alarm output	0%	Stop
Er 0 1 • Alternate display with measured value	• A/D, zero cancel data error	—	0%	Stop
Er 0 2 • Alternate display with measured value	• A/D, C/J data error	—	Control continuation (in the conditions without C.J)	Stop
Er 0 3 • Alternate display with measured value	• A/D, EOC error	—	0%	Stop
Er 0 4 • Alternate display with measured value	• Calibration data error	—	Control continuation (in the conditions not controlled)	Stop

* 1-sec. switching

In case of Er , turn the power OFF then ON again. If the conditions are not changed after that, consult your nearest dealer.

RELATION BETWEEN THE TYPE OF ALARM MODES AND OUTPUT

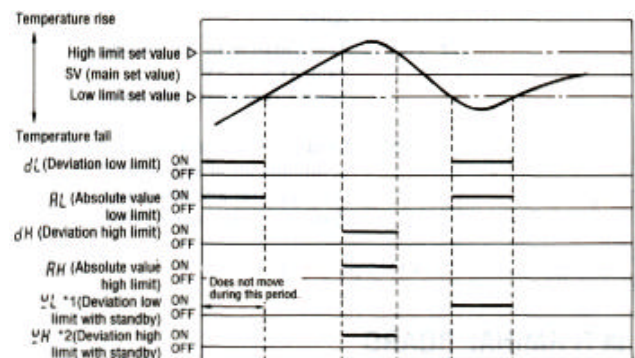

Note) As for the absolute value high or low limit, the set value corresponds to an alarm high or low limit set value.
As for the deviation high or low limit, the value to which the SV is added corresponds to the alarm high or low limit set value.

*1 UL (Deviation low limit with standby)

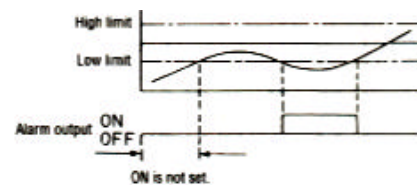

After having entered the normal mode, one alarm is output.

*2 UH (Deviation high limit with standby)

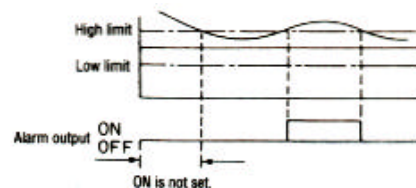

After having entered the normal mode, one alarm is output.

■ OPTIONS

Name of option	Specifications
Transmission signal output	Transmission details — PV or SV transmission is set. Output value — 4 ~ 20 mA DC Load resistance — 500 Ω or less Output accuracy rating — ± 0.5% to the indicated value Output resolution — 1/3000 Isolation — Not isolated from control output (current, SSR); isolated from other input and output terminals 500 V DC, 20 MΩ or more 250 V AC, for 1 minute
Communication	Types of communication — RS 442A Baud rate — One can be selected from 9600, 4800, 2400, 1200. • COM: Communications with host computer Control conditions and settings can be transmitted to a host computer and settings can be received from the host computer. • TRS: Transmission of the indicated value (PV or SV) Transmission cycle of approx. 1sec. • REM: Controls value received via communication as a controlled set value (remote set value) Zone division control possible
DC power	24VDC power drive

■ SWITCHING OF MEASURING RANGE

• Input switch SW1

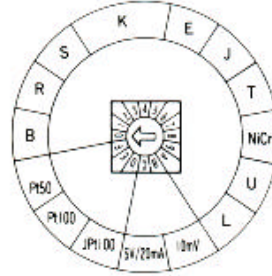

• Input switch SW2

The measuring range of Pt100 can be switched by SW2. Also, the switching of 5 V/20 mA can be performed.

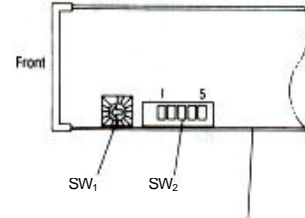

Input/CPU board

• Switch for other functions (SW2)

Number	Switching mode	Selected contents	Switch status	Switch position
1.	Auxiliary switching of the measuring range	Refer to the item of the measuring range		
2.	Power source frequency	50 Hz	OFF	
		60 Hz	ON	
3.	Measuring unit	°C	OFF	
		°F	ON	
4.	Control system	PID	OFF	
		2-positions	ON	
5.	Control mode	Reverse mode	OFF	
		Normal mode	ON	

■ TERMINAL BOARD

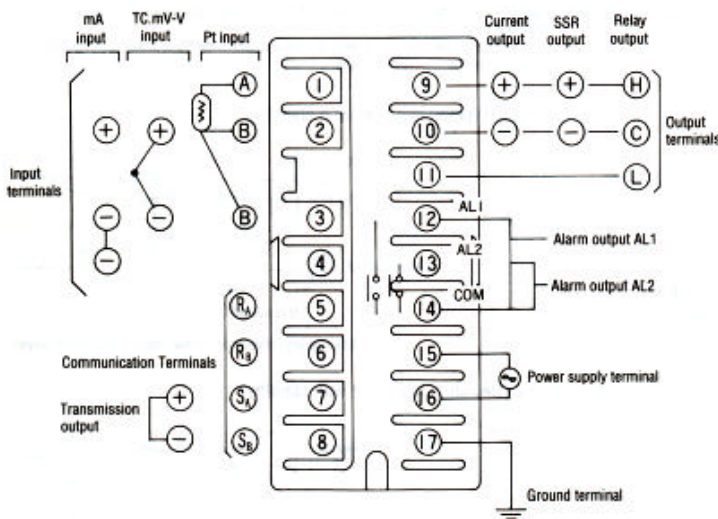

■ EXTERNAL DIMENSIONS AND PANEL CUT-OUT

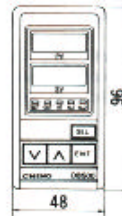

Panel cut-out diagram

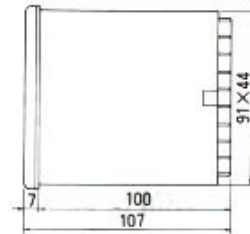

Panel cut-out for side-by-side installation

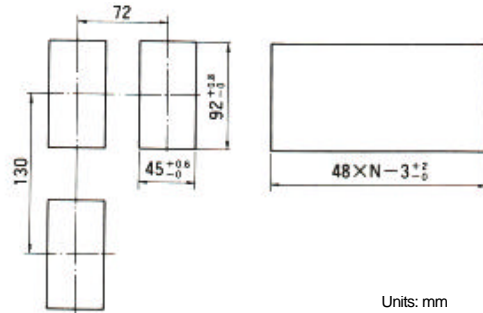

Units: mm

Specifications subject to change without notice. Original

CHINO CORPORATION

32-8, KUMANO-CHO, ITABASHI-KU, TOKYO 173-8632

PHONE: +81-3-3956-2171

FAX: +81-3-3956-0915

E-mail: inter@chino.co.jp

Webside: www.chino.co.jp

Website: http://www.chino.co.jp